

# *ME* DISPLAYS

**SPECIFICATIONS**

**FOR**

**LCD MODULE**

**CCM2020**

**MICRO ELECTRONICS CORPORATION**

3375 Scott Blvd. Suite 222 Santa Clara CA 95054

Tel: 408-988-1101 Fax: 408-988-7626

Email: [micro@microelect.com](mailto:micro@microelect.com)

[Http://www.microelect.com](http://www.microelect.com)

## • FEATURES

Number of Characters	20 characters x 2 lines
Display Font	5 x 8 dots
Built-in Controller	HD44780 or Comp
Input Data	4 Bits or 8-Bits Interface
Power Supply	+5 V Single Power
Duty Cycle	1/16 Duty
Options	EL/LED Backlight, TN/STN

## • MECHANICAL PARAMETERS

Module Size	116.0W x 37.0H x 11.0T mm
Module Size with LED Backlight	116.0W x 37.0H x 24.0T mm
Viewing Area Size	83.6W x 18.5H mm
Dot Size	0.65 x 0.60 mm
Dot Pitch	0.70 x 0.65 mm

## • ABSOLUTE MAXIMUM

Item	Symbol	Min.	Max	Unit
Power Supply for Logic	Vdd	-0.3	+7.0	V
Power Supply for LCD Drive	Vlcd	Vdd-13.5	Vdd+0.3	V
Input Voltage	Vi	-0.3	Vdd+0.3	V
Operating Temperature	Ta	0	+50	C
Storage Temperature	Tstg	-10	+60	C

## • ELECTRICAL CHARACTERISTICS

(Vdd=5.0V ± 5%, Ta=25C)

Item	Symbol	Conditions	Min	Typ	Max	U
Power Supply for Logic	Vdd	--	4.5	--	5.5	V
Op. Voltage for LCD	Vdd-Vo	--	--	5.0	--	V
Input "High" Voltage	Vih	--	2.2	--	Vdd	V
Input "Low" Voltage	Vil	--	-0.3	--	0.6	V
Output "High" Voltage	Voh	- Ioh = 0.2mA	2.4	--	--	V
Output "Low" Voltage	Vol	Iol = 1.2mA	--	--	0.4	V
Power Supply Current	Idd	Vdd = 5.0V	--	0.4	0.6	mA

• **PIN ASSIGNMENT**

No.	Symbol	Level	Pin Description	Function
1	Vss	--	Ground	0V
2	Vdd	--	Supply Voltage for Logic	5V
3	Vo	--	LCD Contrast Adjust	By User
4	RS	H/L	Register Select	H: Data, L: Instruction Code
5	R/W	H/L	Read / Write	H: Data Read, L: Data Write
6	E	H, H→L	Enable	Enable Signal
7	DB0	H/L	Data Bit 0	8-Bit Interface
8	DB1	H/L	Data Bit 1	8-Bit Interface
9	DB2	H/L	Data Bit 2	8-Bit Interface
10	DB3	H/L	Data Bit 3	8-Bit Interface
11	DB4	H/L	Data Bit 4	4 or 8-Bit Interface
12	DB5	H/L	Data Bit 5	4 or 8-Bit Interface
13	DB6	H/L	Data Bit 6	4 or 8-Bit Interface
14	DB7	H/L	Data Bit 7	4 or 8-Bit Interface
15	A	--	LED Backlight	Power Supply for Backlight
16	K	--	LED Backlight	Power Supply for Backlight

• **BLOCK DIAGRAM**

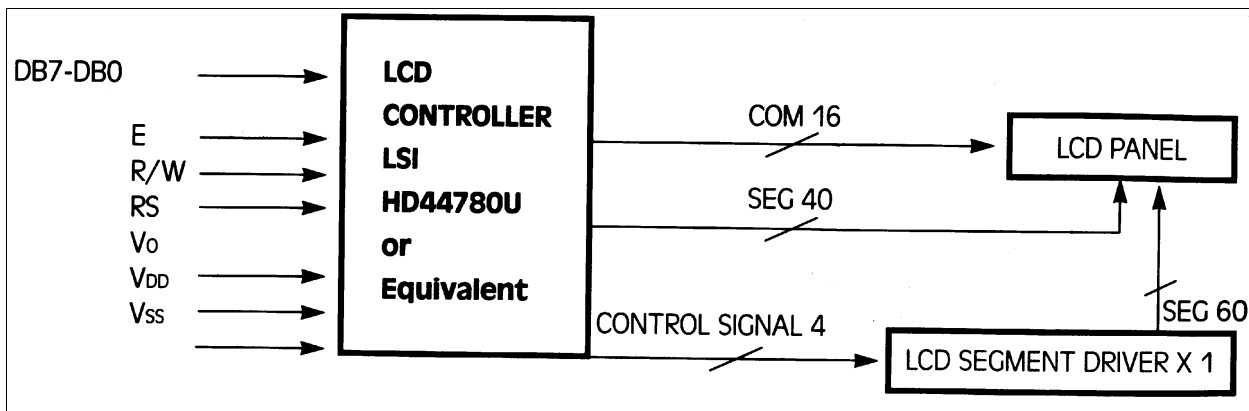

• DIAGRAM CCM2020

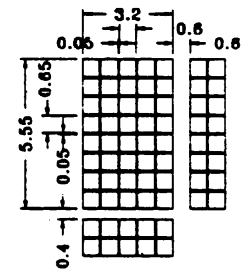
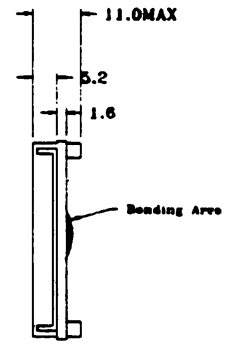
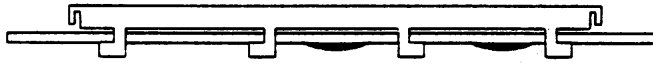
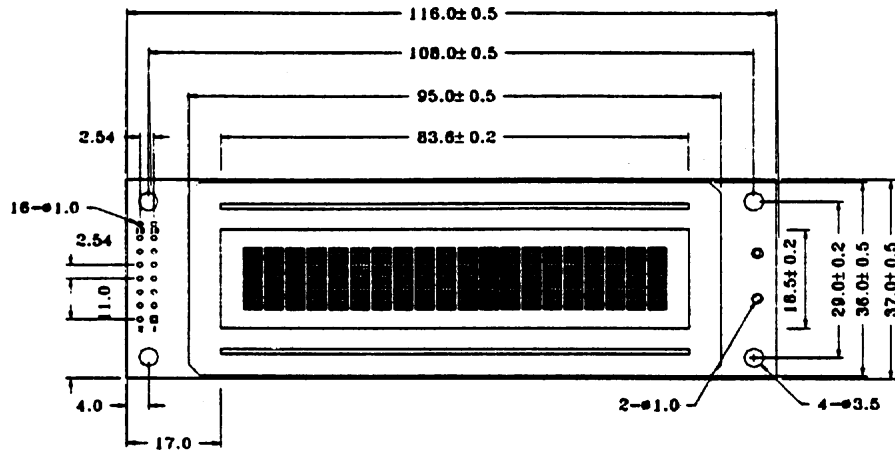

(SCALE 5:1)

- ENVIRONMENTAL CONDITIONS**

Item	Operating		Non-Operating		Remarks
	Min	Max	Min	Max	
Ambient Temperature (Ta)	0°C	50°C	-20°C	70°C	Normal Temperature Type
	-20°C	70°C	-30°C	80°C	Extended Temperature Type
Vibration	--	0.5G	--	2G	G=9.8 m/s <sup>2</sup>
Shock	--	3G	--	50G	XYZ Directions
Corrosion Gas	No Corrosion Gas				

- OPTICAL CHARACTERISTICS**

**TN TYPE**

Item	Symbol	Condition	Min	Typ	Max	Unit
Viewing Angle	Ø2-Ø1	K=1.4	20	--	--	Deg
Contrast Ratio	K	Ø=25° θ=0°	--	3	--	--
Response Time (Rise)	tr	Ø=25° θ=0°	--	200	250	ms
Response Time (Fall)	tf	Ø=25° θ=0°	--	200	300	ms

**STN TYPE**

Item	Symbol	Condition	Min	Typ	Max	Unit
Viewing Angle	Ø2-Ø1	K=1.4	40	--	--	Deg
Contrast Ratio	K	Ø=25° θ=0°	3	--	--	--
Response Time (Rise)	tr	Ø=25° θ=0°	--	200	300	ms
Response Time (Fall)	tf	Ø=25° θ=0°	--	250	350	ms

- **BACKLIGHT CHARACTERISTICS**

**EL BACKLIGHT**

**Electrical Data**

Parameter	Description
Power Supply	Up to max. 230 RMS
Wave Shape	Sinusoidal
Frequency	Up to max. 3 KHz
Efficiency $\eta$	(dvA/cd)
Capacity	0.55 nF/cm <sup>2</sup>
Operating Current	160mA

**Optical Data**

Parameter	Description
Power Supply	110v 400Hz sinusoidal
Luminous Intensity	42 cd/m <sup>2</sup> resp 12.4fl
Emission	Color White(Rose) 564nm x=0.293, y=0.365
Homogeneity	$\pm 5\%$
Useful Life	Unlimited
Brightness Uniformity (Relative Humidity <80%)	1000h approx. 80% 5000h approx. 50%

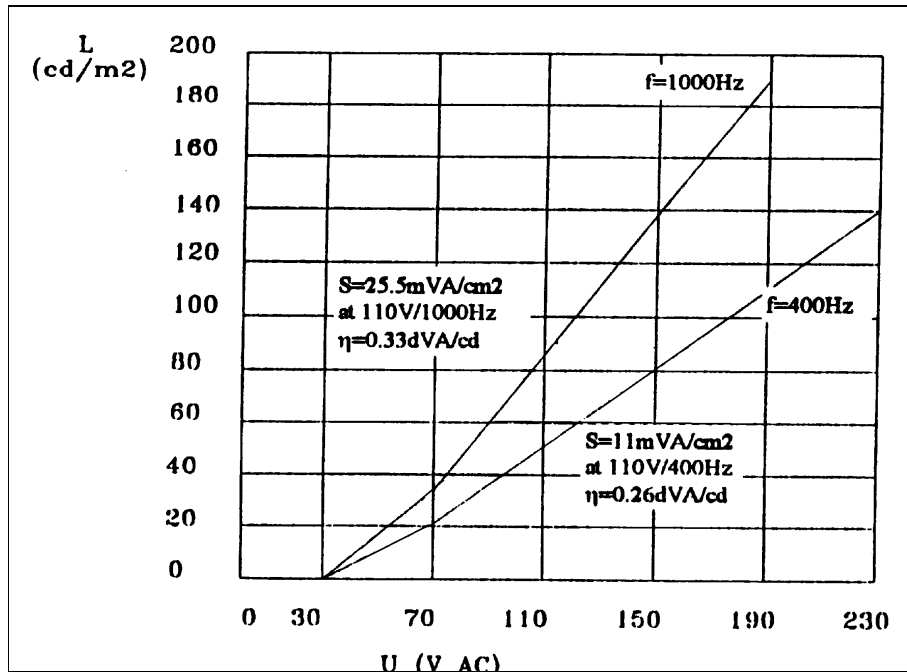

## LED BACKLIGHT

### Characterisitcs

Low Voltage Driving (DC) is available without invertor

No noise occurrence

Life : 20K Hours

Item	Symbol	Conditions	Rating	Unit
Power Dissipation	Pmax	--	1960	mW
Forward Voltage	Vf	Type	4.4	V
Reverse Voltage	Vr min	Ir=1400uA	10	V
Average Forward Current	If max	Vf=4.4V	350	mA

### • AC CHARACTERISTICS

(Vdd=5V ± 10%, Vss=0V, Ta=25°C)

Write Mode (Writing data from Micom to KS070B)

Item	Symbol	Min	Max	Unit
Enable Cycle Time	T <sub>CYCE</sub>	500	--	ns
Enable Pulse Width	PW <sub>EH</sub>	220	--	ns
Enable Rise/Fall Time	t <sub>Er</sub> , t <sub>Ef</sub>	--	25	ns
Address Set-up Time	t <sub>AS</sub>	40	--	ns
Address Hold Time	t <sub>AH</sub>	10	--	ns
Data Set-up Time	t <sub>DSW</sub>	60	--	ns
Data Hold Time (Writing)	t <sub>H</sub>	10	--	ns
Data Hold Time (Reading)	t <sub>DHR</sub>	10	--	ns

### • TIMING CHARACTERISTICS

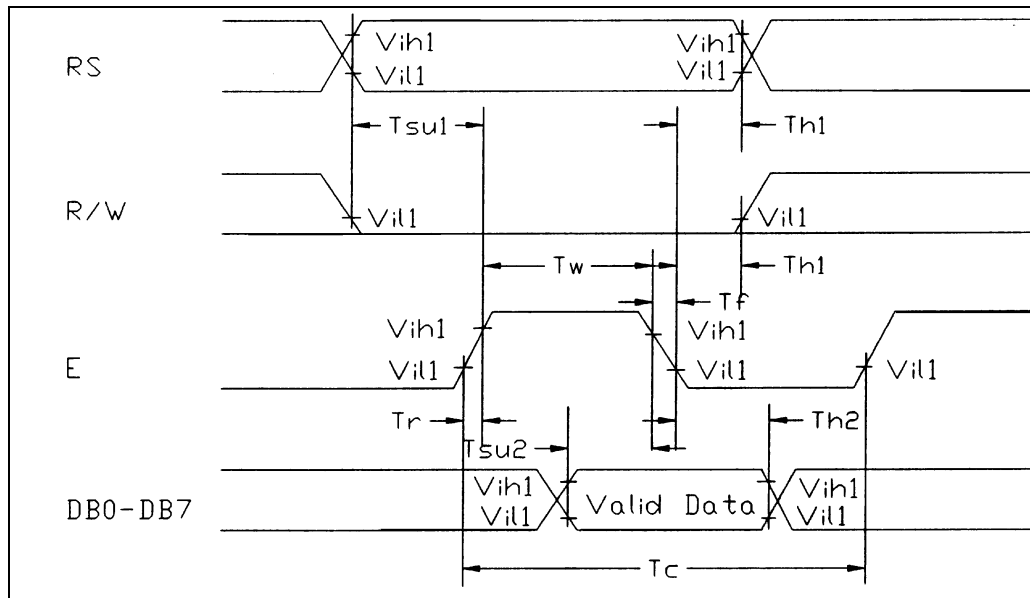

• **CONTROL AND DISPLAY COMMAND**

Command	RS	R/W	DB7	DB6	DB5	DB4	DB3	DB2	DB1	DB0	Remark
Display Clear	L	L	L	L	L	L	L	L	L	H	
Return Home	L	L	L	L	L	L	L	L	H	X	Cursor Moves to First Digit
Entry Mode Set	L	L	L	L	L	L	L	H	I/D	SH	I/D: Set Cursor Move Direction H-Increase L-Decrease SH: Specifies Shift of Display H-Display is Shifted L-Display is Not Shifted
Display On/Off	L	L	L	L	L	L	H	D	C	B	D: Display (H-on, L-off) C: Cursor (H-on, L-off) B: Blinking (H-o, L-off)
Shift	L	L	L	L	L	H	S/C	R/L	X	X	SC: (H-Display Shift, L-Cursor Move) R/L: (H-Right Shift, L-Left Shift)
Set Function	L	L	L	L	H	DL	N	F	X	X	DL: (H-8 Bits Interface, L-4 Bits Interface) N: (H-2 Line Display, L-1 Line Display) F: (H-5 x 10 Dots, L-5 x7 Dots)
Set CG RAM Address	L	L	L	H	CG RAM Address (corresponds to address)					CG RAM Data is Sent and Received After this Setting	
Set DD RAM Address	L	L	H	DD RAM Address					DD RAM Data is Sent and Received After this Setting		
Read Busy Flag & Address	L	H	BF	Address Counter Used for Both DD & CG RAM Address					BF: (H-Busy, L-Ready) -- Reads BF: Indicates Internal Operation is Being Performed. -- Read Address Counter Contents		
Write Data	H	L	Write Data					Write Data into DD or CG RAM			
Read Data	H	H	Read Data					Read Data from DD or CGRAM			